

**SU-matic®**

  
Tooling expert.



ツールホルダー

 **OKUMA**

**2SP-250H 用**  
H / HM / HG / HMG



**SUHNER®**  
EXPERTS. SINCE 1914.



## 貴方の機械の加工能力を増強します。。。







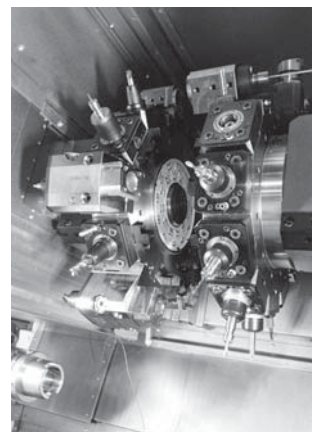
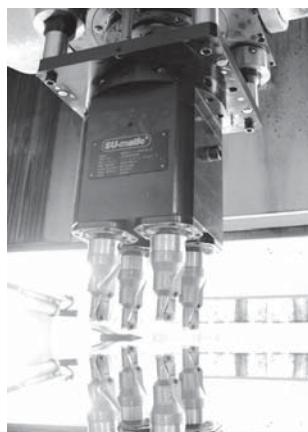
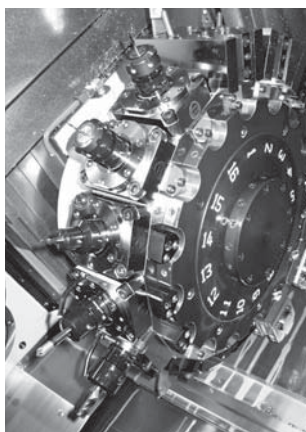

大きな投資をしなくても。。。

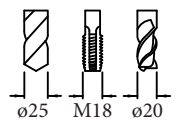
弊社では多軸ヘッド、アングルおよびリボルバーヘッドなど全ての種類のツールホルダーを製造し有名工作機械メーカー殿やOEMメーカーに供給しています。高い性能の装置はDIN規格に準拠し、お客様ご指定のインターフェースに適合しています。標準化された製品の供給は世界的なブランドであるAのアルフレッドシュッテ (ALFRED SCHUTTE,) からWのワールドリッヒ。コブルグ(WALDRICH COBURG)まで拡張しています。

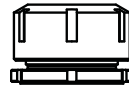
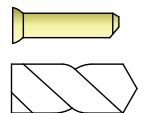

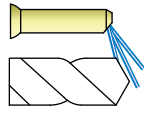

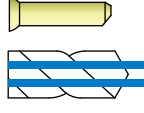
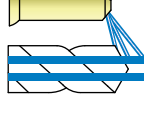



機械メーカーとの新しい製品開発の連携は非常に速い段階から始まります。従って新しい機械が発表された時点で既に実用的な準備はできています。我々は計画、製造、品質管理そしてサービスの全てを自社で行っております。親会社であるスナー(SUHNER)社の世界的な展開により、大きな恩恵を受けています。









# 記号の意味

	品名		品名
	これら3つのシンボルはこのユニットで使用可能な最大切削工具径を示しています (ドリル、タップ、ミーリングカッター)。	#	ユニット部品番号
	内部クーラント型の場合には絶対にドライでは使用しないで下さい。		スピンドル出力インターフェース
	クーラントは使用できません		クーラントタイプ
	外部クーラント		ターニング方向 入力:出力
	内部クーラント	$i$ $n_1 : n_2$	減速比 入力 : 出力
	内部及び外部クーラント	$n_{2 \max}$	出力側の最大回転数 (RPM)
	本キャプトユニットはサンドビックコロマンの認定を受けています (ISO26623-2)。	$T_{2 \max}$	出力側の最大トルク
		# 	特別付属のレンチの部品番号

### ライブツール(回転工具)

	#			$i$ $n_1 : n_2$	$n_{2 \max}$	$T_{2 \max}$	在庫品*	ページ
	14101001820	ERAX 32		1 : 1	5'000 min <sup>-1</sup>	85 Nm	受注生産	6
	14101001840	ERAXC 32		1 : 1	5'000 min <sup>-1</sup>	85 Nm	受注生産	6
	14800002660	ER 32		1 : 1	6'000 min <sup>-1</sup>	85 Nm	受注生産	6
	14800003140	ERC 32		1 : 1	6'000 min <sup>-1</sup>	85 Nm	受注生産	6



### 静止ツール

	#			$i$ $n_1 : n_2$	$n_{2 \max}$	$T_{2 \max}$	在庫品*	ページ
	14910001060	ø40		-	-	-	受注生産	7
	14910001090	ø40		-	-	-	受注生産	7
	14910001070	□25x25		-	-	-	受注生産	8

# 索引

# LOKUMA

## 付属品

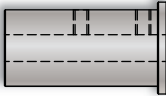
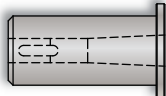
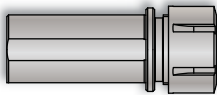
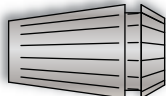
	品名		在庫品*	ページ
	ターレット用プラグ(栓)	-	受注生産	9
	高圧クーラントパイプ	-	受注生産	9
	ø32 / ø40	ø6 - ø25	受注生産	10
	ø32 / ø40	MT 1 - MT 4	受注生産	10
	ø32 / ø40	ER 25 - ER 32	受注生産	10
	コレット	ER 11 - ER 40	受注生産	11

## ライブツール(回転工具)

# LOKUMA

### Lathe Linear Unit Offset • LLUO 85-1 R

SU-matic®

Machine Types 2SP-250H  
HM / HMG

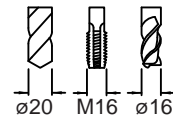
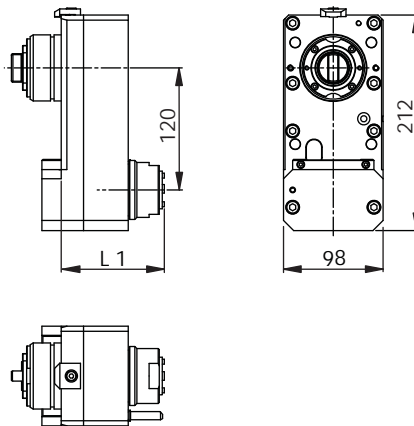
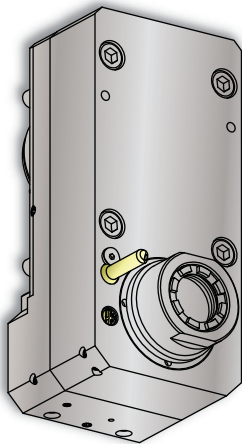

#			$n_1 : n_2$	$i$ $n_1 : n_2$	$n_{2 \max}$	$T_{2 \max}$	L1	#
14101001820	ERAX 32	100 bar		1 : 1	5'000 min <sup>-1</sup>	85 Nm	96.5	14430100850
14101001840	ERAXC 32	50 bar		1 : 1	5'000 min <sup>-1</sup>	85 Nm	101.5	14430100850

### Lathe Angular Unit Offset • LAUO 85-1 A

SU-matic®

Machine Types 2SP-250H  
HM / HMG

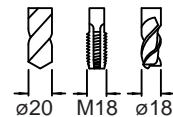
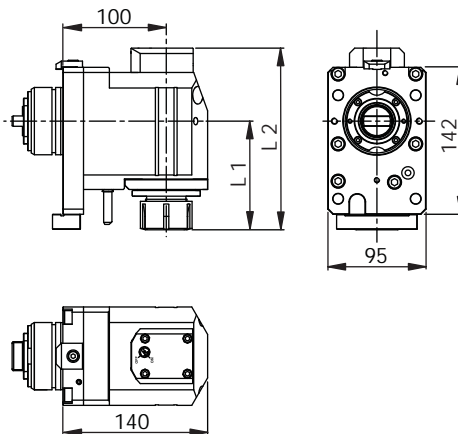
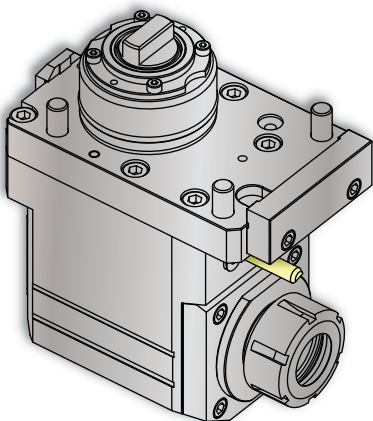

#			$n_1 : n_2$	$i$ $n_1 : n_2$	$n_{2 \max}$	$T_{2 \max}$	L1	L2	#
14800002660	ER 32	100 bar		1 : 1	6'000 min <sup>-1</sup>	85 Nm	100	156	14430100670
14800003140	ERC 32	100 bar		1 : 1	6'000 min <sup>-1</sup>	85 Nm	105	175.5	14430100670

# 静止ツール





# LOKUMA

## Lathe Angular Static • LAS 32-1 A

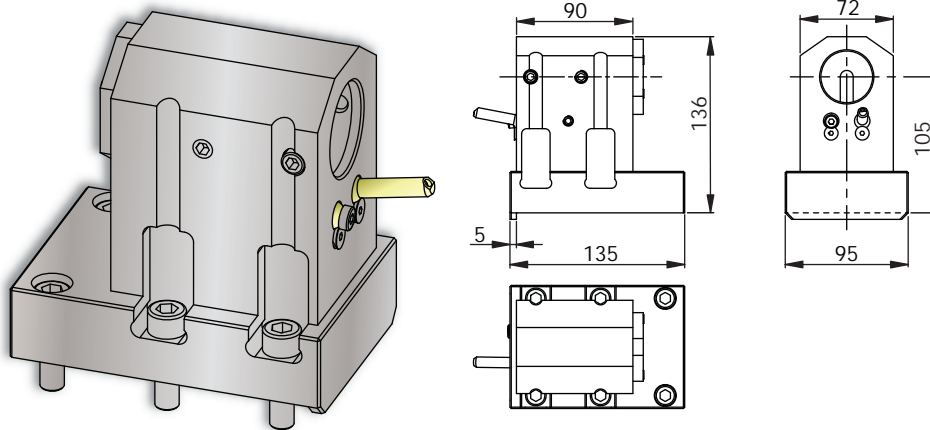
SU-matic®

Machine Types  
2SP-250H  
H / HM / HG / HMG







#				# 
14910001060	ø40	 100 bar		-

## Lathe Angular Static Offset • LASO 40-1 A

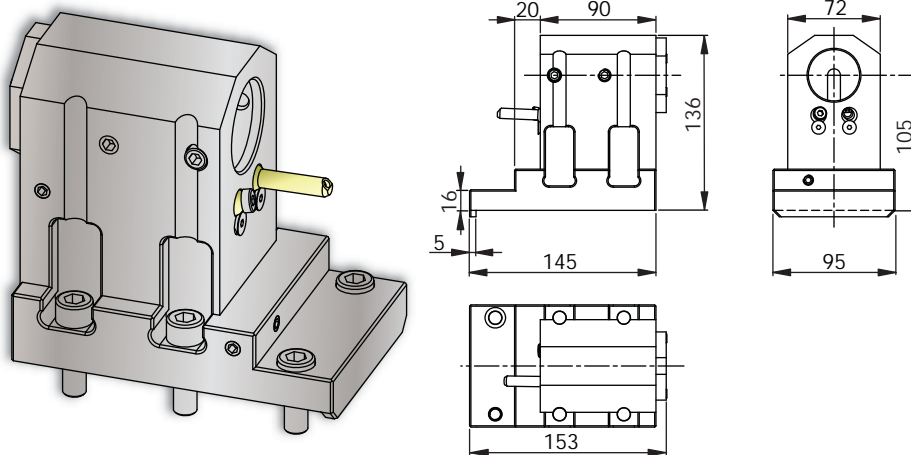
SU-matic®

Machine Types  
2SP-250H  
H / HM / HG / HMG

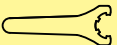

#				# 
14910001090	ø40	 100 bar		-





## 静止ツール

### Lathe Linear Static • LLS 25-1 R

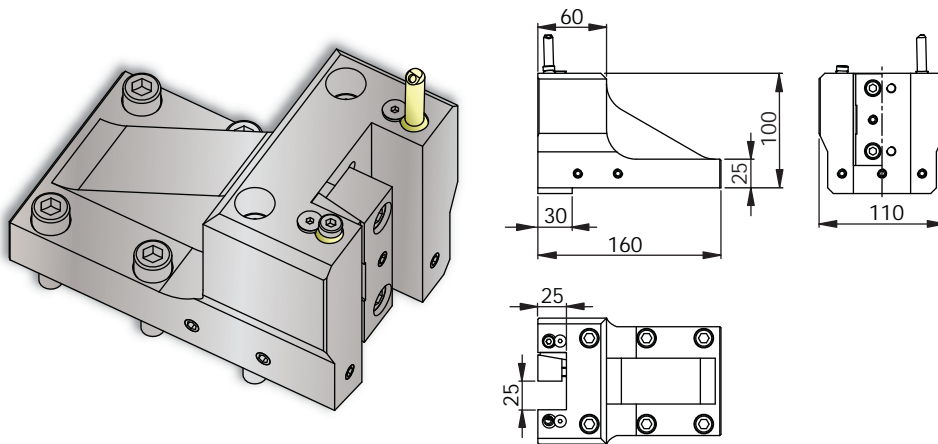
SU-matic®

Machine Types  
2SP-250H  
H / HM / HG / HMG



#				# 
14910001070	□25x25	 100 bar		-



# 付属品

## ターレット用プラグ(栓)

SU-matic®

Machine Types 2SP-250H

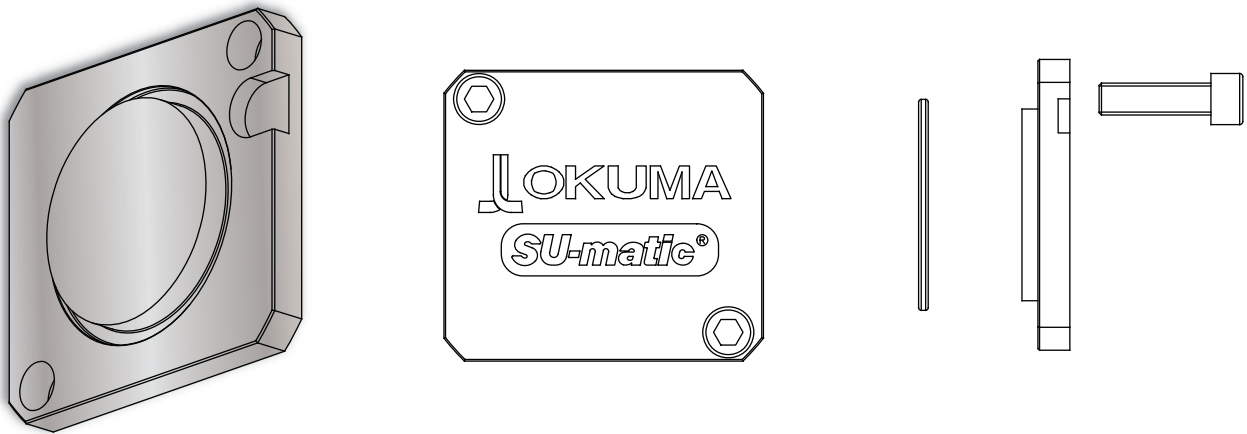

#

14430000410

## 高圧クーラントパイプ

SU-matic®

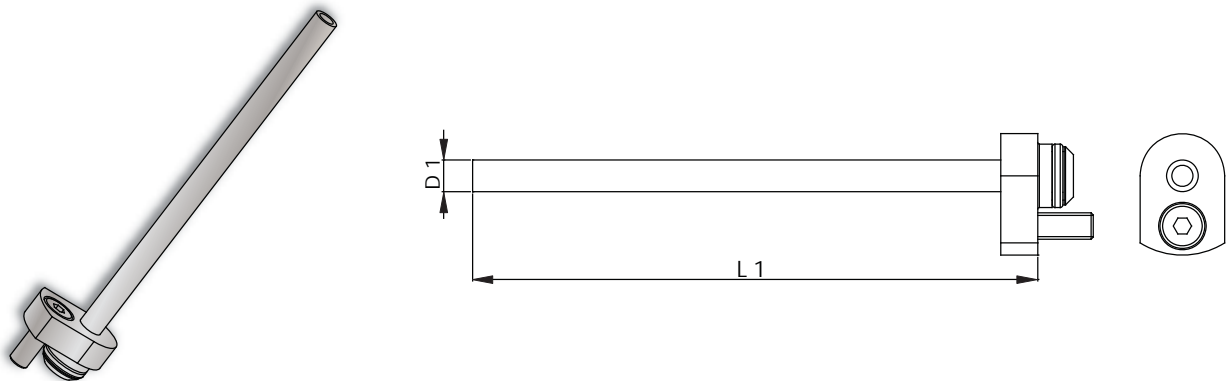

#

L1

D1

14430000750

107

6

## 付属品

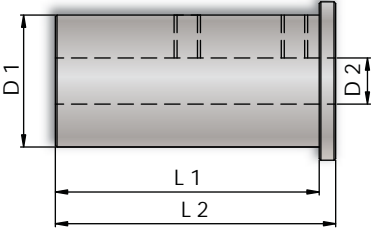
リダクションスリーブ (円筒形)	#		D 1	D 2	L1	L2
	3001404010	Ø 32 x 6 mm	32	6	70	75
	3001404011	Ø 32 x 8 mm	32	8	70	75
	3001404012	Ø 32 x 10 mm	32	10	70	75
	3001404013	Ø 32 x 12 mm	32	12	70	75
	3001404014	Ø 32 x 14 mm	32	14	70	75
	3001404015	Ø 32 x 16 mm	32	16	70	75
	3001404016	Ø 32 x 18 mm	32	18	70	75
	3001404017	Ø 32 x 20 mm	32	20	70	75
	3001405004	Ø 32 x 25 mm	32	25	70	75
	3001404018	Ø 40 x 6 mm	40	6	80	85
	3001404019	Ø 40 x 8 mm	40	8	80	85
	3001404020	Ø 40 x 10 mm	40	10	80	85
	3001404021	Ø 40 x 12 mm	40	12	80	85
	3001404022	Ø 40 x 14 mm	40	14	80	85
	3001404023	Ø 40 x 16 mm	40	16	80	85
	3001404024	Ø 40 x 18 mm	40	18	80	85
	3001404025	Ø 40 x 20 mm	40	20	80	85
	3001404026	Ø 40 x 25 mm	40	25	80	85
	3001405005	Ø 40 x 32 mm	40	32	80	85

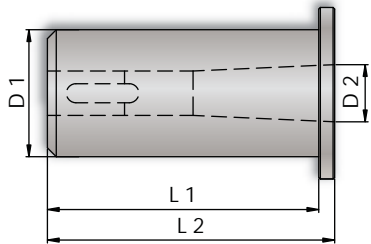
リダクションスリーブ (モールステーパ)	#		D 1	D 2	L1	L2
	3001404010	Ø 32 x MT 1	32	MT 1	85	90
	3001404011	Ø 32 x MT 2	32	MT 2	85	90
	3001404012	Ø 32 x MT 3	32	MT 3	95	100
	3001404018	Ø 40 x MT 2	40	MT 2	105	110
	3001404019	Ø 40 x MT 3	40	MT 3	105	110
	3001404020	Ø 40 x MT 4	40	MT 4	120	125

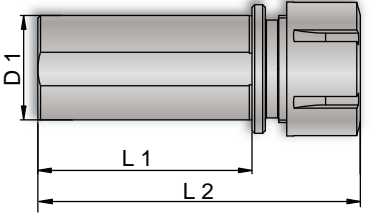
コレットツールホルダー	#		L1	L2	D1	
	14420000870	Ø 32 x ER 25	70	107.5	32	
	14420000880	Ø 40 x ER 32	70	107.5	40	
	14420000810	Ø 40 x ER 32	113	153.5	40	

# 付属品

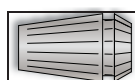

**SU-matic** コレット

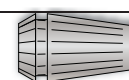

	ER 11	ER 16	ER 20	ER 25	ER 32	ER 40	ER 50
ø 1.00 - 0.50	3900110010	3900160010	3900200010	3900250010	-	-	-
ø 2.00 - 1.00	3900110020	3900160020	3900200020	3900250020	3900320020	-	-
ø 3.00 - 2.00	3900110030	3900160030	3900200030	3900250030	3900320030	3900400030	-
ø 4.00 - 3.00	3900110040	3900160040	3900200040	3900250040	3900320040	3900400040	-
ø 5.00 - 4.00	3900110050	3900160050	3900200050	3900250050	3900320050	3900400050	3900500060
ø 6.00 - 5.00	3900110060	3900160060	3900200060	3900250060	3900320060	3900400060	3900500060
ø 7.00 - 6.00	3900110070	3900160070	3900200070	3900250070	3900320070	3900400070	3900500080
ø 8.00 - 7.00	-	3900160080	3900200080	3900250080	3900320080	3900400080	3900500080
ø 9.00 - 8.00	-	3900160090	3900200090	3900250090	3900320090	3900400090	3900500100
ø 10.00 - 9.00	-	3900160100	3900200100	3900250100	3900320100	3900400100	3900500100
ø 11.00 - 10.00	-	-	3900200110	3900250110	3900320110	3900400110	3900500120
ø 12.00 - 11.00	-	-	3900200120	3900250120	3900320120	3900400120	3900500120
ø 13.00 - 12.00	-	-	3900200130	3900250130	3900320130	3900400130	3900500140
ø 14.00 - 13.00	-	-	-	3900250140	3900320140	3900400140	3900500140
ø 15.00 - 14.00	-	-	-	3900250150	3900320150	3900400150	3900500160
ø 16.00 - 15.00	-	-	-	3900250160	3900320160	3900400160	3900500160
ø 17.00 - 16.00	-	-	-	3900250170	3900320170	3900400170	3900500180
ø 18.00 - 17.00	-	-	-	-	3900320180	3900400180	3900500180
ø 19.00 - 18.00	-	-	-	-	3900320190	3900400190	3900500200
ø 20.00 - 19.00	-	-	-	-	3900320200	3900400200	3900500200
ø 21.00 - 20.00	-	-	-	-	3900320210	3900400210	3900500220
ø 22.00 - 21.00	-	-	-	-	3900320220	3900400220	3900500220
ø 23.00 - 22.00	-	-	-	-	-	3900400230	3900500240
ø 24.00 - 23.00	-	-	-	-	-	3900400240	3900500240
ø 25.00 - 24.00	-	-	-	-	-	3900400250	3900500260
ø 26.00 - 25.00	-	-	-	-	-	3900400260	3900500260
ø 27.00 - 26.00	-	-	-	-	-	3900400270	3900500280
ø 28.00 - 27.00	-	-	-	-	-	3900400280	3900500280
ø 29.00 - 28.00	-	-	-	-	-	3900400290	3900500300
ø 30.00 - 29.00	-	-	-	-	-	3900400300	3900500300
ø 32.00 - 30.00	-	-	-	-	-	-	3900500320
ø 34.00 - 32.00	-	-	-	-	-	-	3900500340
ø 36.00 - 34.00	-	-	-	-	-	-	3900500360

# SUHNER®

## EXPERTS. SINCE 1914.

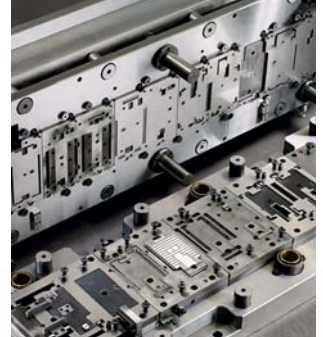

### ABRASIVE

### AUTOMATION

### TRANSMISSION

### STAMPING

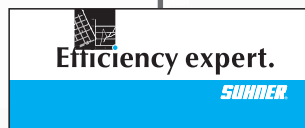

	Switzerland	OTTO SUHNER AG
	Switzerland	SUHNER Automation AG
	Switzerland	SU-matic AG
	Germany	Otto Suhner GmbH
	Austria	SUHNER SU-matic HmbH
	USA	Suhner Industrial Products Corp.
	France	Somex SAS
	Italy	Suhner SU-matic Srl.
	Mexico	SUHNER PRODUCTOS INDUSTRIALES
	India	SUHNER India Pvt. Ltd.
	China	Suhner (Suzhou) Ind. Tech. Ltd.



Lupfig
Lupfig
Lupfig
Bad Säckingen
Wien
Rome, GA
Ensisheim
Zola Predosa
San Juan del Rio
Bangalore
Suzhou



automation.expert@suhner.com
efficiency@suhner.com
info@su-matic.com
automation.de@suhner.com
office.at@suhner.com
automation.usa@suhner.com
info@somex.fr
info.it@su-matic.com
info.mx@suhner.com
automation.in@suhner.com
info.china@suhner.com



+41 (0)56 464 28 28
+41 (0)56 464 28 45
+41 (0)56 464 29 90
+49 (0)7761 557 0
+43 (0)1 587 16 14
+1 (706) 235-8046
+33 (0)3 89 81 12 12
+39 051 6 16 66 73
+52 427 272 39 78
+91 (0) 80- 27 831108
+86 512 628 77 808

[www.suhner.com](http://www.suhner.com)